

The SHM also functions like an SH retaining ring, but in "smaller" applications. It is also a tamper proof ring which does not have any lugs and can not be easily removed once installed.

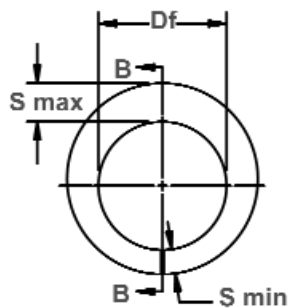

Free Diameter & Ring Measurements with Section B-B

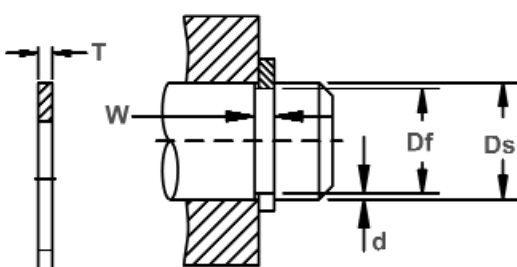

Shaft Diameter & Groove Dimensions

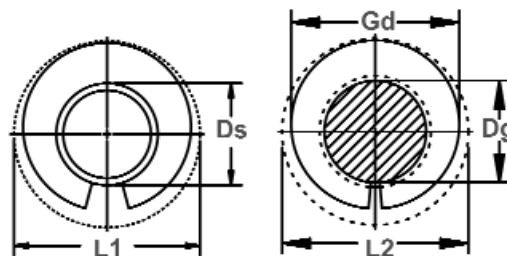

Clearance Diameter & Gaging Diameter

| RING NO. | SHAFT DIAMETER inches | | | GROOVE SIZE | | | | | RING SIZE & WEIGHT | | | | CLEARANCE DIA. | | | i THRUST LD. (lbs.) Sqr. Corner Abutment Groove w/90° wall | |
|----------|-----------------------|--------|----------|-------------|------------|-------|--------|-------|--------------------|-------|--------------|-------|-----------------------|----------------------|---------------------|--|---------------------------|
| | | | | DIAMETER | | WIDTH | | DEPTH | FREE DIAMETER | | THICKNESS*** | | Weight. Per 1000 Pcs. | Ex-panded over shaft | Re-leased in groove | Ring Safety Factor of 4 | Groove Safety Factor of 2 |
| | Ds DEC | Tol. | Ds FRACT | Dg | Tol. | W | Tol. | d | Df | Tol. | T | Tol. | | | | | |
| SHM-10 | .101 | | - | .093 | ±.001 | .024 | | .004 | .090 | | .020 | | .036 | .160 | .152 | | 30 |
| SHM-12 | .125 | ±.001 | 1/8 | .115 | .0015* | .024 | + .002 | .005 | .112 | | .020 | | .050 | .186 | .176 | | 40 |
| SHM-13 | .134 | | - | .124 | | .024 | - .000 | .005 | .120 | ±.002 | .020 | | .059 | .197 | .187 | | 45 |
| SHM-15 | .156 | | 5/32 | .144 | | .029 | | .006 | .140 | | .025 | | .122 | .252 | .240 | ** | 65 |
| SHM-18 | .188 | | 3/16 | .174 | | .029 | | .007 | .168 | | .025 | | .179 | .297 | .283 | SEE NOTE BELOW | 90 |
| SHM-20 | .203 | | 13/64 | .189 | | .029 | | .007 | .180 | | .025 | ±.002 | .167 | .302 | .288 | | 100 |
| SHM-22 | .219 | | 7/32 | .205 | | .039 | | .007 | .200 | ±.003 | .035 | | .334 | .345 | .331 | | 110 |
| SHM-25 | .250 | | 1/4 | .232 | ±.0015 | .039 | | .009 | .224 | | .035 | | .386 | .384 | .366 | ** | 160 |
| SHM-26 | .266 | | 17/64 | .248 | + .002* | .039 | + .003 | .009 | .240 | | .035 | | .467 | .406 | .388 | | 170 |
| SHM-31 | .312 | ±.0015 | 5/16 | .292 | | .039 | - .000 | .010 | .284 | | .035 | | .626 | .478 | .458 | | 220 |
| SHM-32 | .328 | | 21/64 | .308 | | .039 | | .010 | .300 | | .035 | | .688 | .498 | .480 | | 230 |
| SHM-37 | .375 | | 3/8 | .351 | ±.002.002* | .046 | | .012 | .340 | | .042 | | 1.035 | .567 | .543 | | 315 |

*F.I.M. (FULL INDICATOR MOVEMENT)-MAXIMUM ALLOWABLE DEVIATION OF CONCENTRICITY BETWEEN GROOVE AND SHAFT.

i BASED ON HOUSINGS/SHAFTS MADE OF COLD ROLLED STEEL. FOR AN EXPLANATION OF FORMULAS USED TO DERIVE THRUST LOAD AND OTHER PERFORMANCE DATA, CONTACT THE ROTOR CLIP ENGINEERING DEPT.

***FOR PLATED RINGS, ADD .002" TO THE LISTED MAXIMUM THICKNESS. MAXIMUM RING THICKNESS WILL BE A MINIMUM OF .0002"

LESS THAN THE LISTED GROOVE WIDTH (W) MINIMUM.

**CALL FOR INFORMATION:1-800-557-6867

INSTALLATION OF ROTOR CLIP SHM RINGS

Rotor Clip SHM retaining rings can be installed by means of a tapered mandrel and a bushing. The mandrel can be eliminated in applications where the shaft can be easily tapered, as illustrated below.

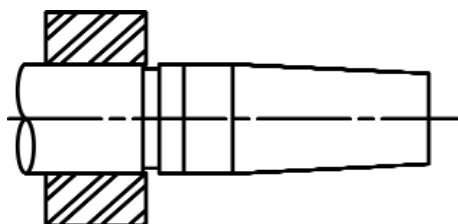

To install, place ring on mandrel and position bushing as shown. Ring can be pushed or tapped into groove.

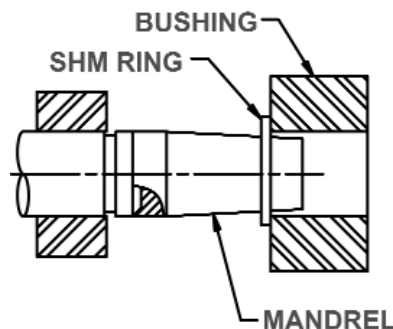

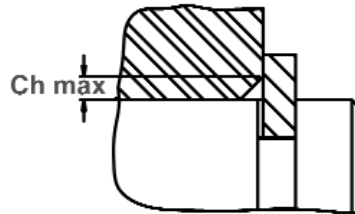
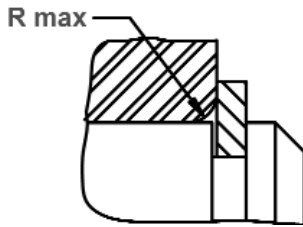

Maximum Corner Radius & Chamfer

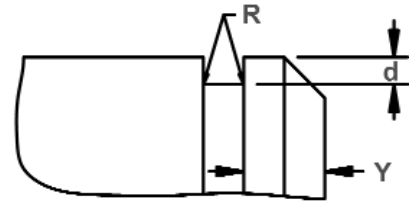

Exploded Groove Profile & Edge Margin (Y)
Maximum bottom radii (R). Sharp corners-
no radii for ring sizes -10 thru -37.

| RING NO. | S Max. | S Min. | GAGING DIA. | ALLOWABLE CORNER RADII & | | MAX. LOAD w/ R max or Ch max. (in lbs.) | EDGE MARGIN | R.P.M. LIMITS Standard material | RING NO. | MANDREL | | | | BUSHING | | | |
|----------|--------|--------|-------------|--------------------------|------|---|-------------|---------------------------------|----------|---------|-------------------|--------|--------------|---------|------|------------------|--------|
| | | | | Ref. | Ref. | | | | | Gd Max | R max | Ch max | i P'r (lbs.) | Y | Dp | Tol. | W ref. |
| SHM-10 | .027 | .017 | .143 | .013 | .010 | SEE NOTE ON PREVIOUS PAGE | .012 | 80000 | SHM-10 | .102 | + .000 - .0015 | .036 | .750 | ± .005 | .104 | + .002 - .000 | 3/8 |
| SHM-12 | .028 | .018 | .167 | .013 | .010 | | .015 | 80000 | SHM-12 | .126 | | .059 | .750 | | .128 | | 3/8 |
| SHM-13 | .029 | .019 | .178 | .014 | .011 | | .015 | 80000 | SHM-13 | .135 | | .069 | .750 | | .137 | | 3/8 |
| SHM-15 | .045 | .027 | .222 | .021 | .017 | | .018 | 80000 | SHM-15 | .157 | | .078 | .875 | | .159 | | 1/2 |
| SHM-18 | .052 | .032 | .264 | .024 | .019 | | .021 | 80000 | SHM-18 | .189 | | .110 | .875 | | .191 | | 1/2 |
| SHM-20 | .046 | .030 | .272 | .023 | .018 | | .021 | 80000 | SHM-20 | .204 | | .125 | .875 | | .206 | | 1/2 |
| SHM-22 | .058 | .036 | .308 | .028 | .022 | | .021 | 80000 | SHM-22 | .221 | | .129 | 1.000 | | .223 | | 1/2 |
| SHM-25 | .063 | .037 | .340 | .028 | .022 | | .027 | 80000 | SHM-25 | .252 | | .101 | 1.000 | | .254 | | 5/8 |
| SHM-26 | .065 | .037 | .359 | .027 | .022 | | .027 | 80000 | SHM-26 | .268 | | .176 | 1.000 | | .270 | | 5/8 |
| SHM-31 | .078 | .050 | .431 | .038 | .030 | | .030 | 80000 | SHM-31 | .314 | | .223 | 1.000 | | .316 | | 5/8 |
| SHM-32 | .080 | .050 | .448 | .038 | .030 | | .030 | 80000 | SHM-32 | .330 | | .238 | 1.000 | | .332 | | 5/8 |
| SHM-37 | .090 | .058 | .511 | .042 | .033 | | .036 | 80000 | SHM-37 | .377 | | .286 | 1.000 | | .379 | | 5/8 |

LARGER SIZES MAY BE AVAILABLE UPON REQUEST.

HARDNESS RANGES: STAINLESS STEEL RINGS (PH 15-7MO)

| RING TYPE | SIZE RANGE | SCALE | ROCKWELL HARDNESS |
|-----------|------------|-------|-------------------|
| SHM | 10-15 | 15N | 82.5-86.0* |
| | 18+ | 30N | 63.0-69.5 |

*HARDNESS CAN NOT BE CHECKED WITH ANY DEGREE OF ACCURACY DIRECTLY ON THESE RINGS.

HARDNESS RANGES: BERYLLIUM COPPER RINGS

| RING TYPE | SIZE RANGE | SCALE | ROCKWELL HARDNESS |
|-----------|------------|-------|-------------------|
| SHM | 10-15 | 15N | 77.0-82.0* |
| | 18+ | 30N | 54-62 |

*HARDNESS CAN NOT BE CHECKED WITH ANY DEGREE OF ACCURACY DIRECTLY ON THESE RINGS.

HARDNESS RANGES: CARBON STEEL RINGS (SAE 1060-1090)

| RING TYPE | SIZE RANGE | SCALE | ROCKWELL HARDNESS |
|-----------|------------|-------|-------------------|
| SHM | 10-15 | 15N | 85.5-87.4* |
| | 18+ | 30N | 68.5-72 |

*HARDNESS CAN NOT BE CHECKED WITH ANY DEGREE OF ACCURACY DIRECTLY ON THESE RINGS.

PRODUCTION OF MANDREL AND BUSHING

Specifications for the production of a mandrel and bushing for installing SHM rings are listed in the above charts. Recommended material is high carbon spring steel, heat treated.

