

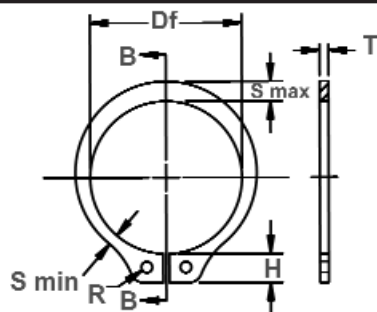

# MSH Shaft Rings

## Axially Assembled, External, ANSI Metric

Once installed in the groove of a shaft, the portion of the ring protruding from the groove (also called a "shoulder") holds an assembly in place.



Free Diameter & Ring Measurements with Section B-B

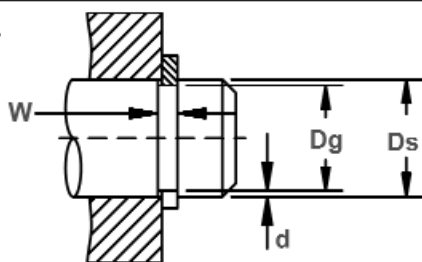

Shaft Diameter & Groove Dimensions

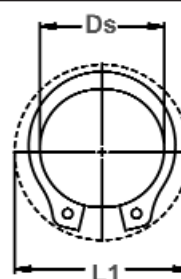

Clearance Diameter Expanded Over Shaft



Clearance Diameter & Gaging Diameter Released in Groove.

RING NO.	SHAFT DIAMETER		GROOVE SIZE						RING SIZE & WEIGHT				CLEARANCE DIA.			THRUST LD (kN)	
			DIAMETER			WIDTH		DEPTH	FREE DIAMETER		THICKNESS ***		Wt. Per 1000 pcs.	Expanded over Shaft	Re-leased in Groove	Sqr. corner abutment	
	Ds mm	Ds INCH	Dg	tol	F.I.M.**	W	tol	d	Df	tol	T	tol				kg	L1
MSH-4*	4	0.157	3.80		0.03	0.32	+0.05	0.10	3.60	+0.05	0.25	±0.05	0.017	7.0	6.8	0.6	0.2
MSH-5*	5	0.197	4.75	-0.08	0.03	0.50	+0.10	0.13	4.55	-0.10	0.40		0.029	8.2	7.9	1.1	0.3
MSH-6*	6	0.236	5.70		0.03	0.50		0.15	5.45		0.40		0.040	9.1	8.8	1.4	0.4
MSH-7	7	0.275	6.60		0.05	0.70		0.20	6.35		0.60		0.10	12.3	11.8	2.6	0.7
MSH-8	8	0.315	7.50	-0.10	0.05	0.70		0.25	7.15		0.60		0.12	13.6	13.0	3.1	1.0
MSH-9	9	0.354	8.45		0.05	0.70		0.28	8.15	+0.05	0.60		0.15	14.5	13.8	3.5	1.2
MSH-10	10	0.393	9.40		0.05	0.70		0.30	9.00	-0.15	0.60		0.19	15.5	14.7	3.9	1.5
MSH-11	11	0.433	10.35		0.05	0.70		0.33	10.00		0.60		0.23	16.4	15.6	4.3	1.8
MSH-12	12	0.472	11.35		0.05	0.70		0.33	10.85		0.60		0.24	17.4	16.6	4.7	2.0
MSH-13	13	0.512	12.30	-0.12	0.10	1.00		0.35	11.90		0.90		0.44	19.7	18.8	7.5	2.2
MSH-14	14	0.551	13.25		0.10	1.00		0.38	12.90		0.90		0.49	20.7	19.7	8.1	2.6
MSH-15	15	0.591	14.15		0.10	1.00		0.43	13.80		0.90		0.54	21.7	20.6	8.7	3.2
MSH-16	16	0.630	15.10		0.10	1.00		0.45	14.70		0.90		0.59	22.7	21.6	9.3	3.5
MSH-17	17	0.669	16.10		0.10	1.00		0.45	15.75		0.90	±0.06	0.64	23.7	22.6	9.9	4.0
MSH-18	18	0.708	17.00		0.10	1.20	+0.15	0.50	16.65		1.10		0.92	26.2	25.0	16.0	4.4
MSH-19	19	0.748	17.95		0.10	1.20		0.53	17.60	+0.15	1.10		0.95	27.2	25.9	16.9	4.9
MSH-20	20	0.787	18.85		0.10	1.20		0.58	18.35	-0.25	1.10		1.0	28.2	26.8	17.8	5.7
MSH-21	21	0.826	19.80	-0.15	0.10	1.20		0.60	19.40		1.10		1.1	29.2	27.7	18.6	6.2
MSH-22	22	0.866	20.70		0.10	1.20		0.65	20.30		1.10		1.3	30.3	28.7	19.6	7.0
MSH-23	23	0.905	21.65		0.10	1.20		0.67	21.25		1.10		1.4	31.3	29.6	20.5	7.6
MSH-24	24	0.945	22.60		0.10	1.20		0.70	22.20		1.10		1.5	34.1	32.4	21.4	8.2
MSH-25	25	0.984	23.50		0.10	1.20		0.75	23.10		1.10		1.6	35.1	33.3	22.3	9.2
MSH-26	26	1.023	24.50		0.10	1.20		0.75	24.05		1.10		1.8	36.0	34.2	23.2	9.6
MSH-27	27	1.063	25.45		0.10	1.40		0.78	24.95		1.30		2.2	37.8	35.9	28.4	10.3
MSH-28	28	1.102	26.40		0.10	1.40		0.80	25.80		1.30		2.3	38.8	36.9	28.4	11.0
MSH-30	30	1.181	28.35		0.15	1.40		0.83	27.90		1.30		2.5	40.8	38.8	31.6	12.3
MSH-32	32	1.260	30.20	-0.20	0.15	1.40		0.90	29.60	+0.25	1.30		2.8	42.8	40.7	33.6	14.1
MSH-34	34	1.339	32.00		0.15	1.40		1.00	31.40	-0.40	1.30		3.1	44.9	42.5	36.0	16.7
MSH-35	35	1.378	32.90		0.15	1.40		1.05	32.30		1.30		3.3	45.9	43.4	37.0	18.1
MSH-36	36	1.417	33.85		0.15	1.40		1.06	33.25		1.30		3.6	48.6	46.1	38.0	18.9
MSH-38	38	1.496	35.80		0.15	1.40		1.10	35.20		1.30		4.0	50.6	48.0	40.0	20.5
MSH-40	40	1.575	37.70		0.15	1.75		1.15	36.75		1.60		5.6	54.0	51.3	52.0	22.6
MSH-42	42	1.654	39.60		0.15	1.75		1.20	38.80		1.60		6.3	56.0	53.2	54.0	24.8
MSH-43	43	1.683	40.50	-0.30	0.15	1.75		1.25	39.65	+0.35	1.60		6.7	57.0	54.0	55.0	26.4
MSH-45	45	1.772	42.40		0.15	1.75	+0.20	1.30	41.60	-0.50	1.60	±0.08	7.0	59.0	55.9	58.0	28.8
MSH-46	46	1.811	43.30		0.15	1.75		1.35	42.55		1.60		7.3	60.0	56.8	59.0	30.4
MSH-48	48	1.890	45.20		0.15	1.75		1.40	44.40		1.60		7.7	62.4	59.1	62.0	33.0
MSH-50	50	1.969	47.20		0.15	1.75		1.40	46.20		1.60		8.2	64.4	61.1	64.0	35.0

\*SIZES -4 THRU -6 STANDARD MATERIAL- CARBON STEEL; OPTIONAL MATERIAL- BERYLLIUM COPPER.

\*\* F.I.M. (FULL INDICATOR MOVEMENT)- MAXIMUM ALLOWABLE DEVIATION OF CONCENTRICITY BETWEEN GROOVE & SHAFT.

† BASED ON HOUSINGS/SHAFTS MADE OF COLD ROLLED STEEL.

FOR AN EXPLANATION OF FORMULAS USED TO DERIVE THRUST LOAD AND OTHER PERFORMANCE DATA CONTACT THE ROTOR CLIP ENGINEERING DEPARTMENT.

\*\*\*FOR PLATED RINGS ADD 0.05 TO THE LISTED MAXIMUM THICKNESS (T) AND BEVELED END THICKNESS (U) VALUES.



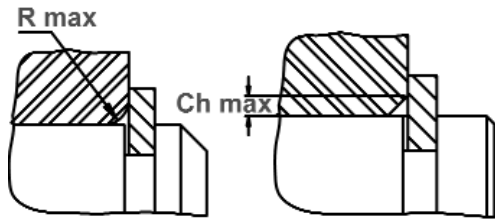

Allowable Corner Radius & Chamfer

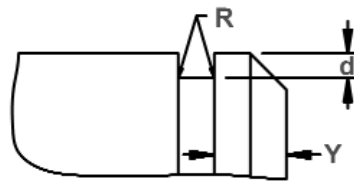

Exploded Groove Profile & Edge Margin (Y)  
Maximum bottom radii (R), 0.10 for ring sizes  
-7 thru -18; 0.2 for ring sizes -19 thru -30;  
0.3 for ring sizes -32 thru -50  
0.4 for ring sizes -52 thru -100

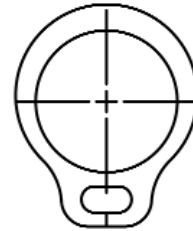

Alternate Lug Design  
For Sizes  
MSH-4 Thru MSH-6

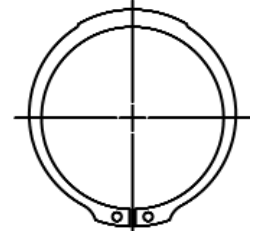

Alternate Design  
(Manufacturer's Option)

RING NO.	LUG HEIGHT	MAXIMUM SECTION	MINIMUM SECTION	HOLE DIAMETER	GAGING DIA.	ALLOWABLE CORNER RADII & CHAMFERS		MAX. LOAD w/ R max or Ch max (kN)	EDGE MARGIN	R.P.M. LIMITS Standard Material
						R max	Ch max			
	H nom	S max/Ref.	S min/Ref.	R min	Gd	R max	Ch max	P'r	Y	RPM
MSH-4*	1.35	0.65	0.40	0.6	4.90	0.35	0.25	0.2	0.3	70000
MSH-5*	1.40	0.65	0.40	0.6	5.85	0.35	0.25	0.5	0.4	70000
MSH-6*	1.40	0.75	0.50	0.6	6.95	0.35	0.25	0.5	0.5	70000
MSH-7	2.05	0.90	0.60	1.0	8.05	0.45	0.3	2.1	0.6	60000
MSH-8	2.20	1.00	0.65	1.0	9.15	0.5	0.35	2.1	0.8	55000
MSH-9	2.20	1.15	0.75	1.0	10.35	0.6	0.35	2.1	0.8	48000
MSH-10	2.20	1.30	0.80	1.0	11.50	0.7	0.4	2.1	0.9	42000
MSH-11	2.20	1.40	0.85	1.0	12.60	0.75	0.45	2.1	1.0	38000
MSH-12	2.20	1.50	0.90	1.0	13.80	0.8	0.45	2.1	1.0	34000
MSH-13	2.80	1.60	0.95	1.2	15.05	0.8	0.5	4.0	1.0	31000
MSH-14	2.80	1.70	1.00	1.2	15.60	0.9	0.5	4.0	1.2	28000
MSH-15	2.80	1.80	1.05	1.2	17.20	1.0	0.6	4.0	1.3	27000
MSH-16	2.80	2.05	1.15	1.2	18.35	1.1	0.6	4.0	1.4	25000
MSH-17	2.80	2.10	1.15	1.2	19.35	1.1	0.6	4.0	1.4	24000
MSH-18	3.45	2.25	1.25	1.3	20.60	1.2	0.7	6.0	1.5	23000
MSH-19	3.45	2.35	1.30	1.3	21.70	1.2	0.7	6.0	1.6	21500
MSH-20	3.45	2.40	1.35	1.3	22.65	1.2	0.7	6.0	1.7	20000
MSH-21	3.45	2.50	1.40	1.3	23.80	1.3	0.7	6.0	1.8	19000
MSH-22	3.45	2.70	1.50	1.3	24.90	1.3	0.8	6.0	1.9	18500
MSH-23	3.45	2.80	1.60	1.3	26.00	1.3	0.8	6.0	2.0	18000
MSH-24	4.20	2.90	1.60	1.9	27.15	1.4	0.8	6.0	2.1	17500
MSH-25	4.20	2.90	1.70	1.9	28.10	1.4	0.8	6.0	2.3	17000
MSH-26	4.20	3.00	1.70	1.9	29.25	1.5	0.9	6.0	2.3	16500
MSH-27	4.60	3.10	1.80	1.9	30.35	1.5	0.9	8.6	2.3	16300
MSH-28	4.60	3.20	1.80	1.9	31.45	1.6	1.0	8.6	2.4	15800
MSH-30	4.60	3.30	1.80	1.9	33.60	1.6	1.0	8.6	2.5	15000
MSH-32	4.60	3.60	1.90	1.9	35.90	1.7	1.0	8.6	2.7	14800
MSH-34	4.60	3.80	2.00	1.9	37.90	1.7	1.1	8.6	3.0	14000
MSH-35	4.60	3.90	2.10	1.9	39.00	1.8	1.1	8.6	3.1	13500
MSH-36	5.40	4.10	2.20	1.9	40.20	1.9	1.2	8.6	3.2	13300
MSH-38	5.40	4.30	2.30	3.1	42.50	2.0	1.2	8.6	3.3	12700
MSH-40	6.00	4.40	2.30	3.1	44.50	2.1	1.2	13.2	3.4	12000
MSH-42	6.00	4.60	2.40	3.1	46.90	2.2	1.3	13.2	3.6	11000
MSH-43	6.00	4.70	2.50	3.1	47.90	2.3	1.4	13.2	3.8	10800
MSH-45	6.00	4.80	2.60	3.1	50.00	2.3	1.4	13.2	3.9	10000
MSH-46	6.00	4.90	2.60	3.1	50.90	2.4	1.4	13.2	4.0	9500
MSH-48	6.20	5.00	2.60	3.1	53.00	2.4	1.4	13.2	4.2	8800
MSH-50	6.20	5.10	2.70	3.1	55.20	2.4	1.4	13.2	4.2	8000

FOR HARDNESS SPECIFICATIONS SEE END OF THE SECTION.





# MSH Shaft Rings

## Axially Assembled, External, ANSI Metric

Once installed in the groove of a shaft, the portion of the ring protruding from the groove (also called a "shoulder") holds an assembly in place.

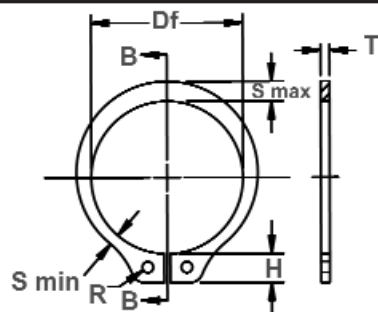

Free Diameter & Ring Measurements with Section B-B

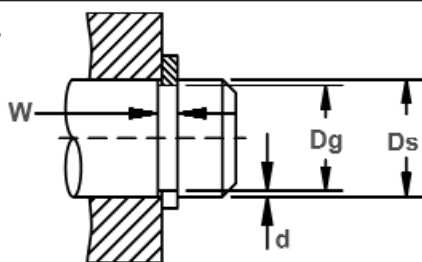

Shaft Diameter & Groove Dimensions

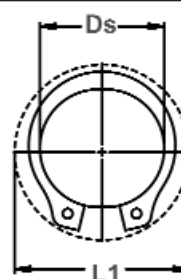

Clearance Diameter Expanded Over Shaft



Clearance Diameter & Gaging Diameter Released in Groove.

RING NO.	SHAFT DIAMETER		GROOVE SIZE					RING SIZE & WEIGHT				CLEARANCE DIA.			THRUST LD (kN)		
			DIAMETER		WIDTH	DEPTH	FREE DIAMETER	THICKNESS ***	Wt. Per 1000 pcs.	Ex-panded over Shaft	Re-leased in Groove	Sqr. corner abutment					
	Ds mm	Ds INCH	Dg	tol	F.I.M.**	W						tol	d	Df	tol	T	tol
MSH-54	54	2.126	51.00	-0.30	0.15	2.15		1.50	49.90		2.00		11.8	69.6	66.1	87.0	40.0
MSH-55	55	2.165	51.80		0.15	2.15		1.60	50.60		2.00		11.9	70.6	66.9	89.0	44.0
MSH-57	57	2.244	53.80		0.20	2.15		1.60	52.90	+0.35	2.00		12.5	72.6	68.9	91.0	45.0
MSH-58	58	2.283	54.70		0.20	2.15		1.65	53.60	-0.65	2.00		12.6	73.6	69.8	93.0	46.0
MSH-60	60	2.362	56.70		0.20	2.15		1.65	55.80		2.00		13.2	75.6	71.8	97.0	49.0
MSH-62	62	2.441	58.60		0.20	2.15		1.70	57.30		2.00		13.4	77.6	73.6	100.0	52.0
MSH-65	65	2.559	61.60		0.20	2.15		1.70	60.40		2.00		15.4	80.6	76.6	105.0	54.0
MSH-68	68	2.677	64.50		0.20	2.15		1.75	63.10		2.00		16.3	83.6	79.5	110.0	58.0
MSH-70	70	2.756	66.40		0.20	2.55	+0.20	1.80	64.60		2.40	±0.08	19.3	88.1	83.9	136.0	62.0
MSH-72	72	2.835	68.30	-0.40	0.20	2.55		1.85	66.60		2.40		20.6	90.1	85.8	140.0	65.0
MSH-75	75	2.953	71.20		0.20	2.55		1.90	69.00		2.40		22.6	93.1	88.7	147.0	69.0
MSH-78	78	3.071	74.00		0.20	2.55		2.00	72.00	+0.50	2.40		21.5	95.4	92.1	151.0	76.0
MSH-80	80	3.150	75.90		0.20	2.55		2.05	74.20	-0.75	2.40		26.8	97.9	93.1	155.0	80.0
MSH-82	82	3.228	77.80		0.20	2.55		2.10	76.40		2.40		28.1	100.0	95.1	159.0	84.0
MSH-85	85	3.346	80.60		0.20	2.55		2.20	78.60		2.40		29.0	103.0	97.9	165.0	91.0
MSH-88	88	3.464	83.50		0.20	2.95		2.25	81.40		2.80		32.2	107.0	100.8	199.0	97.0
MSH-90	90	3.543	85.40		0.20	2.95		2.30	83.20		2.80		33.1	109.0	103.6	204.0	101.0
MSH-95	95	3.740	90.20		0.20	2.95		2.40	88.10		2.80		37.6	114.0	108.6	215.0	112.0
MSH-100	100	3.852	95.20		0.20	2.95		2.42	92.50		2.80		43.1	119.5	113.7	227.0	123.0

\*\* F.I.M. (FULL INDICATOR MOVEMENT)- MAXIMUM ALLOWABLE DEVIATION OF CONCENTRICITY BETWEEN GROOVE & SHAFT.

† BASED ON HOUSINGS/SHAFTS MADE OF COLD ROLLED STEEL.

FOR AN EXPLANATION OF FORMULAS USED TO DERIVE THRUST LOAD AND OTHER PERFORMANCE DATA CONTACT THE ROTOR CLIP ENGINEERING DEPARTMENT.

\*\*\*FOR PLATED RINGS ADD 0.05 TO THE LISTED MAXIMUM THICKNESS (T) AND BEVELED END THICKNESS (U) VALUES.

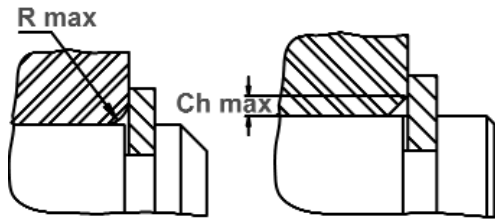

Allowable Corner Radius & Chamfer

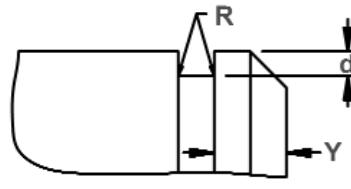

Exploded Groove Profile & Edge Margin (Y)  
 Maximum bottom radii (R), 0.10 for ring sizes  
 -7 thru -18; 0.2 for ring sizes -19 thru -30;  
 0.3 for ring sizes -32 thru -50  
 0.4 for ring sizes -52 thru -100

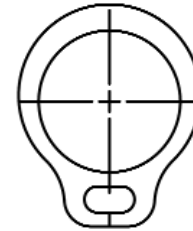

Alternate Lug Design  
 For Sizes  
 MSH-4 Thru MSH-6

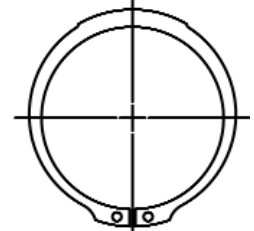

Alternate Design  
 (Manufacturer's Option)

RING NO.	LUG HEIGHT	MAXIMUM SECTION	MINIMUM SECTION	HOLE DIAMETER	GAGING DIA.	ALLOWABLE CORNER RADII & CHAMFERS		MAX. LOAD w/ R max or Ch max (kN)	EDGE MARGIN	R.P.M. LIMITS Standard Material
		S max/Ref.	S min/Ref.			R max	Ch max			
MSH-54	6.80	5.40	2.90	3.1	59.50	2.5	1.5	22.0	4.5	7500
MSH-55	6.80	5.40	2.90	3.1	60.40	2.5	1.5	22.0	4.8	7400
MSH-57	6.80	5.60	3.00	3.1	62.70	2.6	1.5	22.0	4.8	7200
MSH-58	6.80	5.60	3.00	3.1	63.60	2.6	1.6	22.0	4.9	7100
MSH-60	6.80	5.70	3.00	3.1	65.80	2.6	1.6	22.0	4.9	7000
MSH-62	6.80	5.80	3.00	3.1	67.90	2.7	1.6	22.0	5.1	6900
MSH-65	6.80	6.00	3.10	3.1	71.20	2.8	1.7	22.0	5.1	6700
MSH-68	6.80	6.20	3.30	3.1	74.50	2.9	1.7	22.0	5.3	6500
MSH-70	7.80	6.30	3.30	3.1	76.40	2.9	1.7	32.0	5.4	6400
MSH-72	7.80	6.40	3.30	3.1	78.50	2.9	1.7	32.0	5.5	6200
MSH-75	7.80	6.60	3.40	3.1	81.70	3.0	1.8	32.0	5.7	5900
MSH-78	7.80	6.60	3.40	3.1	84.60	3.0	1.8	32.0	6.0	5600
MSH-80	7.80	7.00	3.60	3.1	87.00	3.1	1.9	32.0	6.1	5400
MSH-82	7.80	7.10	3.70	3.1	89.00	3.2	1.9	32.0	6.3	5200
MSH-85	7.80	7.30	3.80	3.1	92.10	3.2	1.9	32.0	6.6	5000
MSH-88	8.40	7.50	3.90	3.1	95.10	3.2	1.9	47.0	6.7	4800
MSH-90	8.40	7.50	3.90	3.1	97.10	3.2	1.9	47.0	6.9	4500
MSH-95	8.40	7.90	4.10	3.1	102.70	3.4	2.1	47.0	7.2	4350
MSH-100	8.70	8.00	4.10	3.1	108.00	3.5	2.1	47.0	7.5	4150

HARDNESS RANGES: STAINLESS STEEL RINGS (PH 15-7MO)

RING TYPE	SIZE RANGE	SCALE	ROCKWELL HARDNESS
MSH	7-21	30N	63-69.5
	22-100	C	44-51

HARDNESS RANGES: CARBON STEEL RINGS (SAE 1060-1090)

RING TYPE	SIZE RANGE	SCALE	ROCKWELL HARDNESS
MSH	7-12	30N	69.5-73
	13-21	30N	67.5-71
	22-26	C	49-53
	27-85	C	48-52
	88-100	C	47-51

