



# DKR Spiral Housing Rings

## DIN 472

### Internal, Heavy Duty DIN

An internal metric ring which meets DIN standards of performance and quality. Our metric rings come standard in 302 stainless steel.

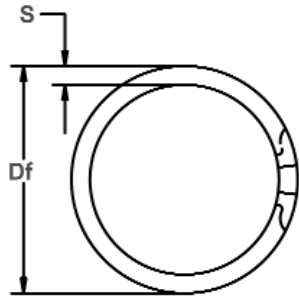

Free Diameter & Ring Measurements

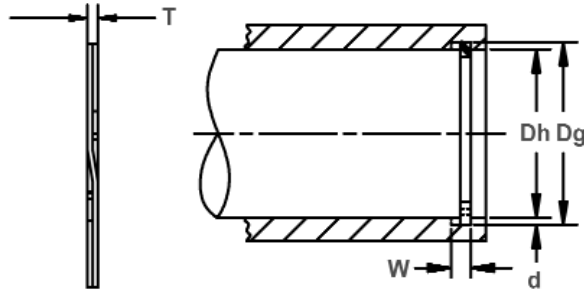

Housing Diameter & Groove Dimensions

RING NO.	HOUSING DIAMETER (mm)	GROOVE SIZE					RING SIZE						THRUST LOAD (N)			
		DIAMETER			WIDTH		DEPTH	FREE DIAMETER			THICKNESS		SECTION		RING Safety factor of 3	GROOVE Safety factor of 2
		Dh	Dg	Tol.	W	Tol.	d	Df	Tol.	T	Tol.	S	Tol.			
DKR-13	13	13,6		1,10		0,3	13,72		0,99		1,40		13474	1901		
DKR-14	14	14,6	+0,11	1,10		0,3	14,75		0,99		1,40		14510	2047		
DKR-15	15	15,7	-0,00	1,10		0,4	15,85		0,99		1,40		15547	2559		
DKR-16	16	16,8		1,10		0,4	16,97		0,99		1,65		16583	3119		
DKR-17	17	17,8		1,10		0,4	17,98	+0,33	0,99		1,65		17620	3314		
DKR-18	18	19,0		1,10		0,5	19,18	-0,00	0,99		1,91		18656	4386		
DKR-19	19	20,0	+0,13	1,10		0,5	20,19		0,99		1,91		19693	4630		
DKR-20	20	21,0	-0,00	1,10		0,5	21,21		0,99		1,91		20729	4874		
DKR-21	21	22,0		1,10		0,5	22,23		0,99		1,91		21766	5117		
DKR-22	22	23,0		1,10		0,5	23,23		0,99		1,91		22802	5361		
DKR-23	23	24,1		1,30		0,6	24,33		1,14		2,18		23853	6165		
DKR-24	24	25,2		1,30	+0,14	0,6	25,45		1,14	±0,05	2,18	±0,10	24891	7018		
DKR-25	25	26,2	+0,21	1,30	-0,00	0,6	26,45		1,14		2,18		25928	7310		
DKR-26	26	27,2	-0,00	1,30		0,6	27,48		1,14		2,18		26965	7603		
DKR-27	27	28,4		1,30		0,7	28,68		1,14		2,41		28002	9211		
DKR-28	28	29,4		1,30		0,7	29,69		1,14		2,41		29039	9552		
DKR-29	29	30,4		1,30		0,7	30,71		1,14		2,41		30076	9893		
DKR-30	30	31,4		1,30		0,7	31,71	+0,38	1,14		2,41		31113	10235		
DKR-31	31	32,7		1,30		0,9	33,02	-0,00	1,14		2,41		32150	12842		
DKR-32	32	33,7		1,30		0,9	34,04		1,14		2,41		33187	13256		
DKR-33	33	34,7	+0,25	1,30		0,9	35,05		1,14		2,41		34224	13670		
DKR-34	34	35,7	-0,00	1,60		0,9	36,07		1,44		3,25		44541	14085		
DKR-35	35	37,0		1,60		1,0	37,38		1,44		3,25		45851	17058		
DKR-36	36	38,0		1,60		1,0	38,39		1,44		3,25		47161	17545		
DKR-37	37	39,0		1,60		1,0	39,40		1,44		3,25		48471	18032		
DKR-38	38	40,0		1,60		1,0	40,41		1,44		3,25		49781	18520		

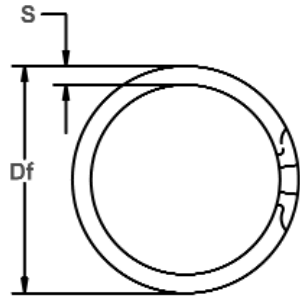

Free Diameter & Ring Measurements

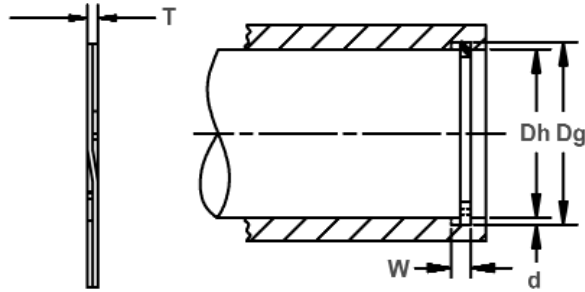

Housing Diameter & Groove Dimensions

RING NO.	HOUSING DIAMETER (mm)	GROOVE SIZE					RING SIZE						THRUST LOAD (N)			
		DIAMETER			WIDTH		DEPTH	FREE DIAMETER			THICKNESS		SECTION		RING Safety factor of 3	GROOVE Safety factor of 2
		Dh	Dg	Tol.	W	Tol.	d	Df	Tol.	T	Tol.	S	Tol.			
DKR-40	40	42,5		1,85		1,3	42,93		1,69		4,01		61498	24368		
DKR-41	41	43,5	+0,25	1,85		1,3	43,94		1,69		4,01		63036	24977		
DKR-42	42	44,5	-0,00	1,85		1,3	44,96	+0,51	1,69	±0,05	4,01	±0,10	64573	25586		
DKR-45	45	47,5		1,85		1,3	47,98	-0,00	1,69		4,01		69186	27414		
DKR-47	47	49,5		1,85		1,3	49,99		1,69		4,01		72261	28633		
DKR-48	48	50,5		1,85		1,3	51,00		1,69		4,01		73798	29242		
DKR-50	50	53,0		2,15		1,5	53,54		1,93		5,08		87790	36552		
DKR-51	51	54,0		2,15		1,5	54,54		1,93		5,08		89546	37283		
DKR-52	52	55,0		2,15		1,5	55,55		1,93		5,08		91302	38014		
DKR-55	55	58,0		2,15		1,5	58,57		1,93		5,08		96569	40207		
DKR-56	56	59,0		2,15	+0,14	1,5	59,59	+0,63	1,93		5,08		98325	40938		
DKR-57	57	60,0		2,15	-0,00	1,5	60,60	-0,00	1,93		5,08		100081	41669		
DKR-58	58	61,0		2,15		1,5	61,62		1,93		5,08		101836	42400		
DKR-60	60	63,0	+0,30	2,15		1,5	63,63		1,93		5,08		105348	43863		
DKR-62	62	65,0	-0,00	2,15		1,5	65,66		1,93	±0,08	5,08	±0,12	108860	45325		
DKR-63	63	66,0		2,15		1,5	66,67		1,93		5,08		110615	46056		
DKR-64	64	67,0		2,15		1,5	67,67		1,93		5,08		112371	46787		
DKR-65	65	68,0		2,65		1,5	68,67		2,41		5,08		135725	47518		
DKR-67	67	70,0		2,65		1,5	70,67		2,41		5,08		139901	48980		
DKR-68	68	71,0		2,65		1,5	71,67		2,41		5,08		141989	49711		
DKR-70	70	73,0		2,65		1,5	73,67		2,41		5,08		146165	51173		
DKR-72	72	75,0		2,65		1,5	75,67	+0,76	2,41		5,08		150341	52635		
DKR-75	75	78,0		2,65		1,5	78,68	-0,00	2,41		5,08		156605	54828		
DKR-76	76	79,0		2,65		1,5	79,68		2,41		5,08		158694	55559		
DKR-78	78	81,0	+0,35	2,65		1,5	81,69		2,41		5,08		162870	57021		
DKR-80	80	83,5	-0,00	2,65		1,8	84,19		2,41		6,05	±0,13	167046	68231		

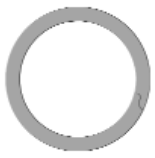

# DKR Spiral Housing Rings

## DIN 472

### Internal, Heavy Duty DIN

An internal metric ring which meets DIN standards of performance and quality. Our metric rings come standard in 302 stainless steel.

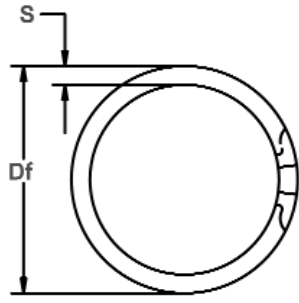

Free Diameter & Ring Measurements

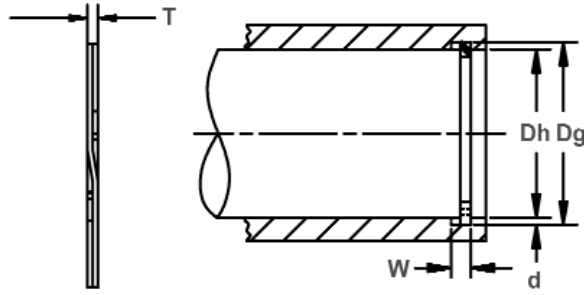

Housing Diameter & Groove Dimensions

RING NO.	HOUSING DIAMETER		GROOVE SIZE				RING SIZE				THRUST LOAD (N)								
			DIAMETER		WIDTH		DEPTH	FREE DIAMETER		THICKNESS		SECTION		RING Safety factor of 3	GROOVE Safety factor of 2				
	Dh (mm)	Dg	Tol.	W	Tol.	d	Df	Tol.	T	Tol.	S	Tol.							
DKR-82	82	85,5	+0,35 -0,00	2,65	+0,14 -0,00	1,8	86,20	+0,76 -0,00	2,41	±0,08	6,05	±0,13	171222	69936					
DKR-85	85	88,5		3,15		1,8	89,20		2,91		6,05		214309	72495					
DKR-88	88	91,5		3,15		1,8	92,21		2,91		6,05		221873	75054					
DKR-90	90	93,5		3,15		1,8	94,21		2,91		6,05		226915	76759					
DKR-92	92	95,5		3,15		1,8	96,22		2,91		6,05		231958	78465					
DKR-95	95	98,5		3,15		1,8	99,24		2,91		6,05		239522	81024					
DKR-98	98	101,5		3,15		1,8	102,26		2,91		6,05		247068	83583					
DKR-100	100	103,5		3,15		1,8	104,29		2,91		6,05		252128	85288					
DKR-102	102	106,0		4,15		2,0	106,79		3,89		6,73		343778	99422					
DKR-105	105	109,0		4,15		2,0	109,79		3,89		6,73		353889	102346					
DKR-108	108	112,0	+0,54 -0,00	4,15	+0,18 -0,00	2,0	112,80	+1,30 -0,00	3,89	±0,10	6,73	±0,15	364000	105270					
DKR-110	110	114,0		4,15		2,0	114,83		3,89		6,73		370741	107220					
DKR-112	112	116,0		4,15		2,0	116,84		3,89		6,73		377482	109169					
DKR-115	115	119,0		4,15		2,0	119,86		3,89		6,73		387593	112093					
DKR-120	120	124,0		4,15		2,0	124,92		3,89		6,73		404445	116967					
DKR-125	125	129,0		4,15		2,0	129,97		3,89		6,73		421297	121840					
DKR-127	127	131,0		4,15		2,0	131,97		3,89		6,73		428038	123790					
DKR-130	130	134,0		4,15		2,0	135,00		3,89		6,73		438149	126714					
DKR-135	135	139,0		+0,63 -0,00		4,15	+0,18 -0,00		2,0		140,03		+1,40 -0,00	3,89	±0,10	6,73	±0,15	455001	131588
DKR-140	140	144,0				4,15			2,0		145,11			3,89		6,73		471852	136461
DKR-145	145	149,0	4,15		2,0	150,11		3,89	6,73	488704	141335								
DKR-150	150	155,0	4,15		2,5	156,13		3,89	7,92	505556	182761								
DKR-155	155	160,0	4,15		2,5	161,19		3,89	7,92	522408	188853								
DKR-160	160	165,0	4,15		2,5	166,22		3,89	7,92	539260	194945								
DKR-165	165	170,0	4,15		2,5	171,27		3,89	7,92	556112	201037								
DKR-170	170	175,0	4,15		2,5	176,33		3,89	7,92	572964	207129								

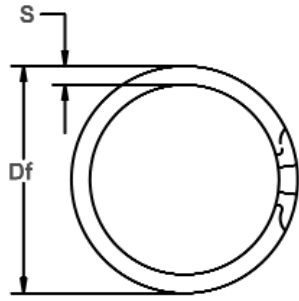

Free Diameter & Ring Measurements

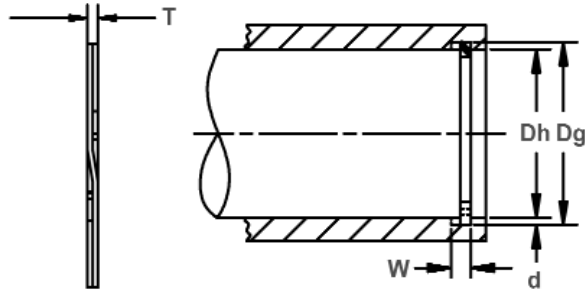

Housing Diameter & Groove Dimensions

RING NO.	HOUSING DIAMETER (mm)	GROOVE SIZE					RING SIZE						THRUST LOAD (N)			
		DIAMETER			WIDTH		DEPTH	FREE DIAMETER			THICKNESS		SECTION		RING Safety factor of 3	GROOVE Safety factor of 2
		Dg	Tol.		W	Tol.	d	Df	Tol.	T	Tol.	S	Tol.			
DKR-175	175	180,0	+0,63 -0,00	4,15		2,5	181,36	+1,40	3,89		7,92		589815	213221		
DKR-180	180	185,0	+0,72 -0,00	4,15	+0,18 -0,00	2,5	186,39	-0,00	3,89	±0,10	7,92	±0,15	606667	219313		
DKR-185	185	190,0		4,15		2,5	191,44	3,89	7,92							
DKR-190	190	195,0		4,15		2,5	196,47	3,89	7,92							
DKR-195	195	200,0		4,15		2,5	201,52	3,89	7,92							
DKR-200	200	205,0	+0,81 -0,00	4,15	+0,18 -0,00	2,5	206,58	+1,78 -0,00	3,89	±0,13	7,92	±0,19	674075	243681		
DKR-210	210	216,0		5,15		3,0	217,58		4,86		9,53					
DKR-220	220	226,0		5,15		3,0	227,66		4,86		9,53					
DKR-230	230	236,0		5,15		3,0	237,72		4,86		9,53					
DKR-240	240	246,0	+0,89 -0,00	5,15	+0,22 -0,00	3,0	247,80	+3,05 -0,00	4,86	±0,13	9,53	±0,19	968484	336280		
DKR-250	250	256,0		5,15		3,0	257,89		4,86		9,53					
DKR-260	260	268,0		5,15		4,0	269,93		4,86		11,18					
DKR-270	270	278,0		5,15		4,0	280,01		4,86		11,18					
DKR-280	280	288,0	+0,89 -0,00	5,15	+0,22 -0,00	4,0	290,09	+3,56 -0,00	4,86	±0,13	11,18	±0,19	1179024	545845		
DKR-290	290	298,0		5,15		4,0	300,15		4,86		11,18					
DKR-300	300	308,0		5,15		4,0	310,24		4,86		11,18					
DKR-310	310	320,0		6,20		5,0	322,25		5,87		12,70					
DKR-320	320	330,0	+0,89 -0,00	6,20	+0,22 -0,00	5,0	332,33	+3,56 -0,00	5,87	±0,13	12,70	±0,19	1576625	755411		
DKR-330	330	340,0		6,20		5,0	342,42		5,87		12,70					
DKR-340	340	350,0		6,20		5,0	352,50		5,87		12,70					
DKR-350	350	360,0		6,20		5,0	362,56		5,87		12,70					
DKR-360	360	370,0	+0,89 -0,00	6,20	+0,22 -0,00	5,0	372,64	+3,56 -0,00	5,87	±0,13	12,70	±0,19	1780060	852883		
DKR-370	370	380,0		6,20		5,0	382,73		5,87		12,70					
DKR-380	380	390,0		6,20		5,0	392,79		5,87		12,70					
DKR-390	390	400,0		6,20		5,0	402,84		5,87		12,70					
DKR-400	400	410,0	6,20	5,0	412,93	5,87	12,70									